

# Red-D-Arc Weld Automation

reddarc.com

## USER MANUAL

### MID DUTY

# COLUMN & BOOM 9FT X 9FT

Model MD (UL Specification)  
Fixed Base



For use with products having Serial Number 07496 and following

TABLE OF CONTENTS

TABLE OF CONTENTS..... 2

1.0 Preface ..... 4

    1.1 Using This Manual..... 4

    1.2 Safety Notices ..... 5

    1.3 Disclaimer ..... 5

2.0 Introduction ..... 6

    2.1 Purpose and Function of a Column & Boom Manipulator ..... 6

    2.2 Nomenclature Used in this Manual..... 6

3.0 Safety ..... 7

    3.1 Introduction ..... 7

    3.2 Safety Rules ..... 7

    3.3 Users ..... 7

    3.4 Workspace ..... 8

    3.5 Emergency Stops ..... 8

    3.6 Non Compliant Operation ..... 9

    3.7 Warning Signs ..... 9

    3.8 Emission and Environmental Information ..... 9

4.0 Operating Instructions ..... 10

    4.1 Machine Details ..... 10

    4.2 Control Panel ..... 10

    4.3 Pendant..... 11

    4.4.1 Set UP ..... 12

        STAGE 1 ..... 12

        STAGE 2 ..... 12

        STAGE 3 ..... 12

        STAGE 4 ..... 13

        STAGE 5 ..... 13

        STAGE 6 ..... 14

        STAGE 7 ..... 14

    4.5.1 Switching On ..... 14

    4.5.2 Electrical Phase Connection..... 15

    4.5.3 Operating the Column & Boom ..... 15

    4.5.4 Welding..... 15

    4.5.5 Stopping the Column & Boom ..... 16

    4.6 Common Mistakes When Using Column & Booms ..... 16

    4.7 Breakdowns ..... 16

    4.8 Cleaning ..... 16

5.0 Maintenance and Servicing.....	17
5.1 General .....	17
5.2 Installation .....	17
5.3 Storage.....	18
5.4 Repair and Maintenance .....	18
5.5 Repairs and Replacement Parts.....	19
6.0 Replacement Parts .....	20
6.1 MECHANICAL PARTS LIST.....	20
6.2 ELECTRICAL PARTS LIST.....	21
Appendix A – Overview Drawing .....	22
Appendix B – Wiring Diagram.....	23
Appendix C – Inverter Parameter Settings .....	24
Appendix D – Gearbox Maintenance .....	25
D.1 Measures before startup .....	25
D.1.1 Oil level check .....	25
D.1.1.1 Checking the oil level in the gear unit housing .....	25
D.1.1.2 Oil sight glass (Special feature) .....	26
D.1.1.3 Dipstick (Special feature) .....	26
D.1.2 Startup without long term preservation.....	26
D.1.3 Startup in case of long term preservation .....	26
D.1.3.1 Long term preservation up to 18 months.....	26
D.1.3.2 Long term preservation up to 36 months .....	26
D.1.4 Filling with lubricant.....	27
D.1.5 Drive with backstop .....	27
D.2 Maintenance and repair.....	28
D.2.1 General Information on Maintenance .....	28
D.2.2 Description of maintenance and repairs.....	29
D.2.2.1 Perform oil change or oil flushing .....	29
D.2.2.2 Clean vent plug.....	30
D.2.2.3 Clean the drive .....	30
D.2.2.4 Checking all fixing screws for tightness.....	30
D.2.2.5 Inspection of the drive .....	31
D.2.3 Lubricants.....	31
Appendix E – Certifications .....	33
E.1 CE Certificate.....	33
E.2 UL Listing.....	34
E.3 CAS Listing.....	35

## 1.0 PREFACE

This user's manual describes the everyday use and maintenance of our Column & Boom Manipulators. Any actions that are required to be carried out by the manufacturer have not been included in this manual.

**This manual is part of the machine. Please keep this manual safe. Information in this manual could be useful at a later time or when a repair or maintenance is carried out. We suggest that a copy of the manual is made and kept with the machine; the original should be kept in a safe place. If necessary, replacement copies can be supplied. If the machine is sold at a later date then the manual should be also supplied with it to the new user.**

## 1.1 USING THIS MANUAL

The instruction in this manual are arranged for various personnel at the end users factory. The definitions in this manual, for these users are as follows;





User :	The collective term for anyone working at or on the column & boom.
Operator:	This is the person that operates or drives the machinery on a daily basis. <b>Read Chapters: 2 Introduction, 3 Safety and 4 Operation.</b>
Service Engineer	Personnel trained and experienced in maintenance and repair of mechanical or electrical elements of machine systems. <b>Read Chapters: ALL CHAPTERS</b>
Safety Officer	The person responsible for site safety procedures at the location where the rotators are installed. Where no Safety Officer is designated, then this will be the employer. <b>Read Chapters : 2 Introduction, 3 Safety and 4 Operation</b>

In this manual the word "vessel" is used to mean any component or device that is being welded.

All the pictures and diagrams used in this manual are purely for illustrative purposes only, to help explain instructions in the text. The actual equipment supplied may deviate slightly from those illustrated.

## 1.2 SAFETY NOTICES

The following Safety notices in this document are organized as follows:

Safety notice	Description
 Danger!	Disregarding the safety regulations and guidelines can be life-threatening.
 Warning!	Disregarding the safety regulations and guidelines can result in severe injury or heavy damage to the column & boom and/or vessel.
 Caution!	Disregarding the safety regulations and guidelines can result in injury or damage to the column & boom and/or vessel.
 Information:	Important information used to prevent errors.

## 1.3 DISCLAIMER

We reserve the right to change the content of this manual without prior notice. The information contained herein is believed to be accurate as of the date of publication, however, Key Plant Automation Ltd, makes no warranty, expressed or implied, with regards to the products or the documentation contained within this document. Key Plant Automation Ltd. shall not be liable in the event if incidental or consequential damages in connection with or arising from the furnishing, performance or use of these products. The software names, hardware names and trademarks used in this document are registered by the respective companies.

## 2.0 INTRODUCTION

### 2.1 PURPOSE AND FUNCTION OF A COLUMN & BOOM MANIPULATOR

The column & boom manipulator is designed to aid the welding of vessels both longitudinally and circumferentially.

By using the motors to raise and lower the boom and also to drive the boom forwards and backwards, the weld head mounted at the end of the boom can be correctly positioned for the required weld.

### 2.2 NOMENCLATURE USED IN THIS MANUAL

Below are listed explanations of commonly used phrases used in this manual.

Column	Vertical axis of the column and boom
Boom	Horizontal axis of the column & boom
Base	The floor mounting plate
Slewing Ring	Ring bearing that the column is bolted to on the base.
Panel	Electrical control box mounted on the Column
Pendant	Operators hand control Pendant

## 3.0 SAFETY

### 3.1 INTRODUCTION

The column & boom has been designed and manufactured in such a way that it can be used and maintained safely.



This relies on following the instructions as detailed in this manual, therefore it is **necessary** for anyone working with or on this machine to have read this manual.

### 3.2 SAFETY RULES

- Ensure that children or animals do not have access to the machinery at any time.
- Any safety items fitted, must not be bypassed, or removed. If they have to be removed then the equipment must be put out of operation, until a repair is completed.
- Always keep the workplace clean and free from obstacles.
- Make sure that the work area is well lit.
- Ensure that the machine is regularly maintained to ensure that it remains safe.

### 3.3 USERS

#### **OPERATORS**

The column & boom may only be operated by adults, who have read and understood this manual, in particular the sections on Safety and Operating Instructions.

Specialised training is not necessary, but experience in working with this kind of equipment is required.

The tasks of the operator will include;

- Raising and lowering the boom to the correct working height for the weld head.
- Moving the boom forward and backward to position head correctly for welding.
- Setting the speed of the boom forward/reverse travel, for welding longitudinally.
- Daily Maintenance Checks
- Observing the column & boom while it is operating.
- Keeping the column & boom clean.

#### **SERVICE ENGINEERS**

Service Engineers must be aware of the extra risks when working on the machine. As well as the above knowledge for operators, the service engineer must also;

- Have received the required training/education or knowledge as necessary for the local regulations regarding service engineers.
- Must have experience in maintaining and servicing machinery.
- Have access to correct tools required to service/repair the machinery.



### 3.4 WORKSPACE



By this we mean a clear space around the column & boom. The free space required around the column & boom should be based on a circle with the column at the centre. The radius of the circle being scribed is when the boom is fully forward, i.e. welding head at the furthest point from the column. From within the workspace all operations and servicing can be carried out. Ensure that any protrusions on the vessel cannot cause any injury or damage.

### 3.5 EMERGENCY STOPS



It is vitally important for the safety of the operators and any other personnel in the area of the rotators, that the operator fully understands the location and how to use the emergency stop buttons on the machine. It is also recommended that other personnel that work in the vicinity of the rotators are also aware of the positions of emergency stop buttons, so they can stop the equipment if the operator requires assistance or is trapped.

Firstly all new operators should be made aware of these emergency stop procedures.

There are two emergency stop buttons fitted on the column & boom, one is located on the panel mounted on the column, on the on the operators control stand.

Pressing either of these two buttons will immediately bring the column & boom to a stop and all controls will be locked.

In case of personal injury, help can be given immediately, also if there is other urgent action required this can be carried out immediately.

After the hazard has been resolved and after checking the machine can be safely operated again, the emergency stop button needs to be released by twisting it in the direction of the arrows printed on it. Once this is done, normal operation will continue.

Note either emergency stop button can be used to stop the machine but operation can only restart again once the reset button is pressed.



We recommend

- New operators are allowed to practise with the emergency stop switches
- The Emergency Stop is tested at the start of every shift



**NEVER DISCONNECT OR BYPASS THE EMERGENCY STOP BUTTONS**



### 3.6 NON COMPLIANT OPERATION



The column & boom is not suitable for the following types of operations.

- Carrying any weight on the boom that is greater than the SWL for the machine.
- Operating the machine on any kind on incline.

In addition the following is also prohibited;

- The mounting of additional controls which are not approved by the manufacturer.

### 3.7 WARNING SIGNS

On the machines there will be various warning signs. These should be checked to ensure that they remain visible and readable at all times. If necessary order replacements.



Warning symbols are on the machine for a reason. Check them regularly to ensure they are always affective.

### 3.8 EMISSION AND ENVIRONMENTAL INFORMATION

The column & boom itself does not contain substances that are dangerous to humans. There are no specific dangers in the operation, maintenance or dismantling of this machinery regarding the environment.

In the event of a fire standard fire extinguishing equipment may be used as suitable.

## 4.0 OPERATING INSTRUCTIONS

Before operating the column & boom please ensure that you have read Chapter 2 – “Safety”. This chapter of the manual is meant for the operators, though all people concerned with the machines should read it.

### 4.1 MACHINE DETAILS

The column & boom will usually consist of a column, a boom and a base.

The column is supplied complete with the boom carriage mounted onto it. The carriage is driven via a rack and pinion up and down the carriage. A fail safe device is fitted to the carriage, so that if drive to the carriage brakes, then the carriage will lock into position, preventing the boom from falling and causing injury.

The boom, is fitted with a rack, for drive via a pinion forwards and backwards. The motor is inverter controlled so that the speed of the boom may be varied

The base is fitted with a ring bearing that allows the column to rotate through 360° around its vertical axis. On the base are also clamps so that the column can be locked into the desired position.

### 4.2 CONTROL PANEL

The control panel on the column has the following controls;

1. Power On Lamp
2. Reset Button
3. Boom Up Button
4. Boom Down Button
5. Panel door opening key
6. Emergency Stop Button- To restart the machine after the emergency stop has been pressed; simply twist this button, in the direction shown by the arrows. The button will then spring back to its normal position. Then press the “Reset” button and the column can be started again.
7. Door electrical isolator, must be turned off before panel door can open.

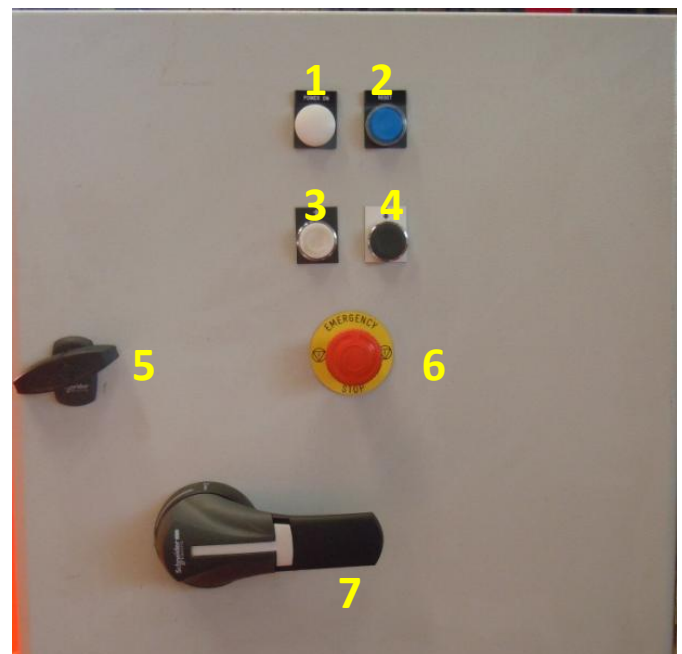

*Figure 1 Main Panel*

## 4.3 PENDANT

The hand pendant has the following controls

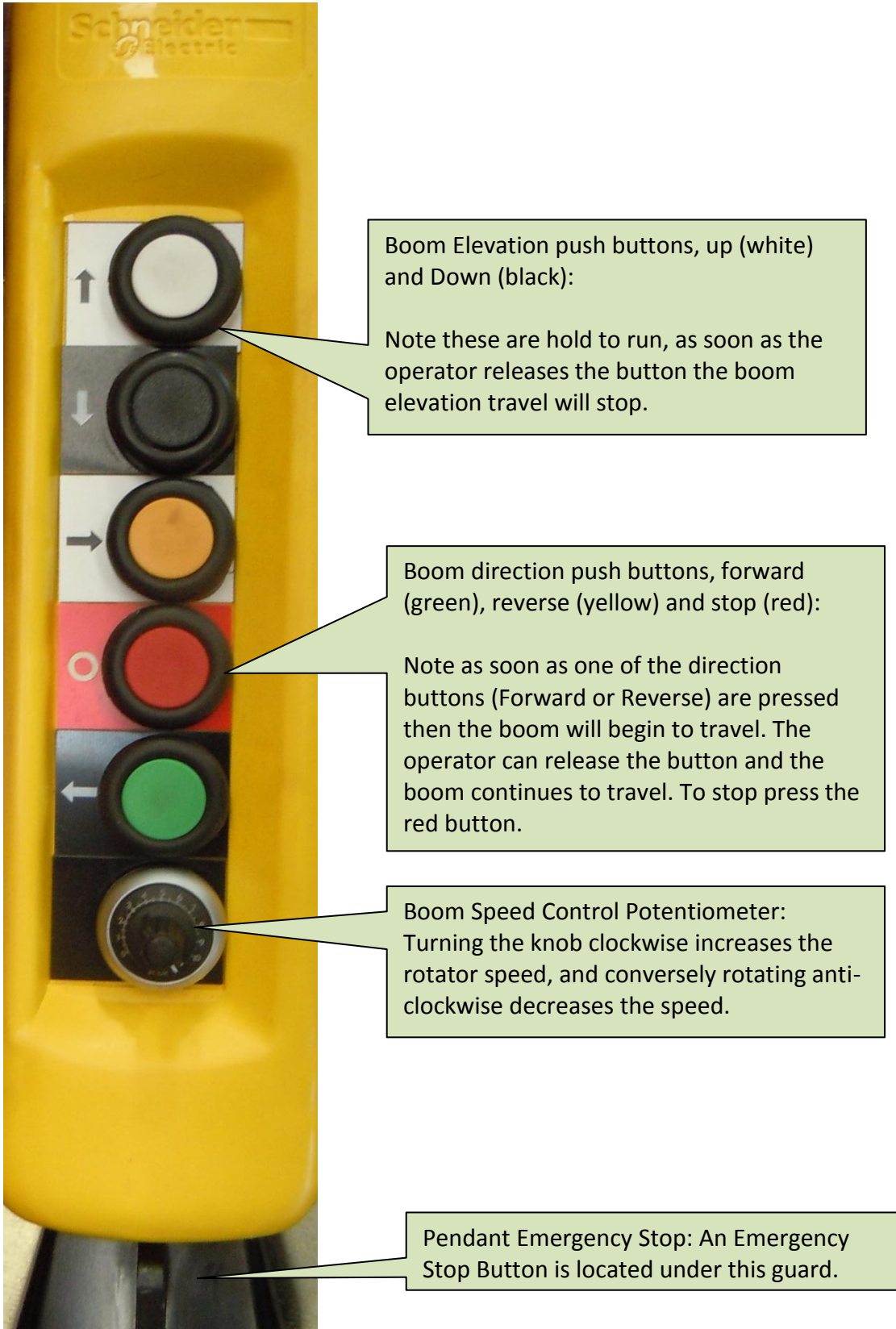

Figure 2 Hand Control Pendant



We recommend that the operator always presses stop, before changing the travel direction of the boom.

## 4.4.1 SET UP

The following stages of assembly must be followed in order to ensure that the machine is correctly commissioned.

Column & Booms are dismantled prior to shipment with the base, column and boom being forwarded with adequate protection or packing for overseas shipments. Furthermore, the machine is dismantled in such a way as to minimise the assembly work at site.

### **STAGE 1**

Remove all anti-corrosion protection from the machine slide-ways, rollers etc. Light oil may be applied to these slide-ways to prevent discolouration.

#### **FIXED BASE:**

Locate the base on perfectly flat floor area and check with spirit level on rotating or fixed centre.

#### **TRAVERSING BOGIE:**

Track should be provided using correct rail section and laid perfectly flat and parallel at required track gauge. The four wheels must always be in contact with the rails to ensure stability and smooth traverse. For traversing bogies with 2 double flanged and 2 plain wheels, the rail for the double flanged must be flat and perfectly straight. The other rail should be flat, and near parallel as possible. Lock the rotating centre of the slewing ring on the base and clean its surface of anticorrosive.

### **STAGE 2**

Heavy Duty Columns are despatched from our factory with a safety bar through the tubular section, to prevent the counterweight moving inside the column during transit. The Safety Bar should not be removed until the Column has been raised by overhead crane and bolted to the fixed base or traversing bogie. This bar is not fitted on Mid Duty Columns

If for any reason the wire rope connecting the carriage to the counterweight has become slack during transit, the carriage may be lowered down the column by releasing the electro-magnetic brake on the elevation geared motor unit.

### **STAGE 3**

The Column may now be raised by overhead or mobile crane using the lifting eyes at the top of the Column.



Care should be taken when raising the Column to avoid the Column swinging and becoming a hazard and possibly causing injury to persons in the vicinity or other items of infrastructure or the machine itself.

Remove the section of channel bolted to the bottom of the Column. Clean the Column flange and lower Column on to the traversing bogie/fixed base and securely bolt in position.

The carriage securing bracket may now be removed. This bracket is locked on the underside of the carriage.

## STAGE 4

Remove from the opposite end of the boom, from where the weld head will be located, the traverse limit cam. Also remove the wire reel bracket from the end of the boom if supplied. Remove wooden cone from end of insulated tube, also if supplied. Remove aluminium grommet from side of boom.

Ensure that the top rollers on the carriage are fully raised in order to give maximum clearance when feeding the Boom into the carriage.

Release the double lock nuts on the roller shafts and turn the eccentric shafts until the roller is in the highest position. The eccentric roller shafts may be turned in either direction.

Raise the Boom by crane and feed the end of the Boom, which has had the cam removed into the carriage. When the Boom is halfway through the carriage and resting on the bottom rollers, lower the top rollers until they are contact with the slides and then lock the two nuts on each eccentric roller shaft.



**DO NOT** over tighten the eccentric rollers on the boom this is unnecessary and will overload the Boom drive motor.

## STAGE 5

Refit the boom traverse limit cam, wooden cone and wire reel bracket if supplied with machine. Also refit the aluminium grommet which is essential if the cables are not to be chafed.

The Boom traverse drive baseplate may now be fitted to the carriage, but ensure that the spur gear meshes correctly with the rack on the side of the Boom.

If a welding head control box support cabinet has been supplied this may now be fitted at the end of the boom. The welding head may also be mounted together with cross slides, if supplied.

If the main control panel has been removed, to ensure safe transportation to site then this should now be mounted at the rear of the Column. In addition, the cable carrier bracket should also be fitted at the rear of the Column nut, above the main control panel.

If a welding rectifier or generator support platform has been supplied for the machine, this may now be bolted in position on the side of the Column.

## STAGE 6

The machine is now fully assembled and may be wired in accordance with the schematic diagram provided. The required mains power may now be connected to the column.

When commissioning the machine the remote control speed potentiometers should be turned to a low speed setting i.e. turns anticlockwise.

The forward or reverse pushbutton may now be pressed to start the boom or bogie traverse motion at a slow speed. The boom limits should be checked at low speed to ensure that they are capable of stopping the motor at maximum forward or reverse traverse.

On heavy duty columns, lower the carriage and raised the cast iron counterweight clear of the safety bar, the bar must then be removed from the column.

## STAGE 7

The Column and Boom should now function correctly and give satisfactory performance over long periods. It is recommended that gearbox oil levels are checked before being put into operation. Occasionally gearbox breather plugs are replaced by solid plugs to avoid oil spillage during transit. The correct breather plugs should be fitted. Always ensure that the carriage rollers are in contact with the slides and that the slides are kept clean and free of scale.

### 4.5.1 SWITCHING ON

Before switching on the column & boom, check the following;

- Visually inspect the rollers, runners, motors, gearboxes, pendant, panel and cables for any signs of damage.
- Has the transport bar for the counterweight been removed?
- Are there any obstructions to prevent full travel of the boom up/down and in/out.
- Check column & boom rack and pinions are in mesh.



**WARNING!** Do not operate the column & boom if there are signs of damage, always have a service engineer to check these over and make repairs if necessary.

Once the operator is satisfied that the equipment is in good order, plug in the mains lead to the power supply.



**WARNING!** Check that the mains power supply matches the electrical voltage shown on the panel.



**WARNING!** Ensure that the mains and pendant cables, do not cross lanes where forklift trucks or other vehicles can run over them, and they do not create a tripping hazard.

Switch on the mains power, and the Power On lamp on the control panel should illuminate.

## 4.5.2 ELECTRICAL PHASE CONNECTION

When power is connected the white “Power On” lamp should illuminate.

Next press the blue “Reset” button. This should then illuminate also, and the system is then ready to operate.

If the Reset button does not illuminate, then first check that all of the Emergency Stop buttons on the control panels and pendants are released, and press the reset button again.

If the reset button still does not illuminate, then the phase connection may be incorrect. Check the Phase Detector Relay inside the panel. This has a red LED light on it. If the phases are correct the red light will be on permanently, if they are incorrect the red LED will flash continuously. Swap over wires L1 and L3 from the incoming mains supply to the isolator inside the control panel.

Once this is complete, and the reset button is illuminated, the machine is ready to operate.

## 4.5.3 OPERATING THE COLUMN & BOOM

Ensure that there is nothing in the path of the column & boom when moving.

The operator can use the UP and Down button on either the control panel or the pendant to set the correct height for the boom.

The operator should then set the speed potentiometer knob (*see figure 2*) to the desired speed of the boom horizontal travel..

Then press the desired travel direction (**GREEN** or **YELLOW** button) the boom will then start to move off in the desired direction.

## 4.5.4 WELDING

It is important that the user is aware of the earthing requirements of their welding procedure, and that this is correctly connected to the vessel before welding.



**WARNING!** The column & boom is insulated from the welding equipment and welding wire. It is important to ensure the insulated ducting for the welding wire and also insulation at the points where the welding equipment is bolted to the boom are in good condition at all times



It is good practise to keep the column & boom clean. Any arc sparks, flux or slag that falls onto the machine should be removed as soon as is possible.



## 4.5.5 STOPPING THE COLUMN & BOOM

To stop the boom, press the **RED** stop button on the hand pendant. This will stop boom travel, which will not restart until a direction button is pressed.

If necessary the column & boom can be stopped using the Emergency Stop Button on either the panel or hand pendant. This should only be used in an emergency. To restart the machine, twist the Emergency Stop button to release it, then press the reset button on the control panel. The column can then be operated.

## 4.6 COMMON MISTAKES WHEN USING COLUMN & BOOMS

1. Over-tightening the rollers on the boom. This will cause the motor to become overloaded and the inverter will trip.
2. Parts of the vessel come into contact with the boom in the vicinity during rotation. This can cause damage to the column & boom and welding heads.
3. Emergency Stop button is depressed. If a switch is pressed in, the operator must find out who pressed it in and for what reason, before restarting the machine. There may be a hazard that someone else has seen and stopped the machine for.
4. The phases of the electrical supply are incorrect for the operation of the machine. It must be checked for both up and down travel of the boom and horizontal travel of the boom, that the limit switch for the direction that the boom is travelling in stops the boom. If it does not then the phases will need swapping over.

## 4.7 BREAKDOWNS

If the column & boom stops working, then the equipment must only be repaired by qualified service personnel.



If there are repeat faults, then this could indicate a problem with the machine. Inform the person on site that is responsible for service and maintenance.

## 4.8 CLEANING

The column & boom require no special cleaning instructions. The machine should not create any pollution to the environment around them during normal operation, although, the welding process being carried out on them may pollute the rotators.



It is good practise to keep the column & boom clean. Any arc sparks, flux or slag that falls onto the machine should be removed as soon as is possible.



**WARNING!** Column & boom must be electrically isolated before cleaning. Any electrical components must not come in contact with water or other cleaning fluids.

## 5.0 MAINTENANCE AND SERVICING

This chapter should be read by all service engineers that will be working on these rotators.

### 5.1 GENERAL



**WARNING!** During all maintenance or repair procedures, the column & boom must be electrically isolated. Do this by switching off the main electrical supply and unplugging the mains cable.



**WARNING!** After disconnecting the power there may be some residual charge in some components in the panel. Wait a few minutes after disconnecting the mains power before commencing work on any electrical elements of the machine.

### 5.2 INSTALLATION

Before first use, or after maintenance or repair work, or after a period of the column & boom being in storage, they will need to go through this installation procedure.

Before the column & boom was despatched from the factory, it will have been fully tested for correct functioning and therefore they can be directly put into operation without the need for any further test time. We would though recommend that the operations of all controls are tested before the equipment is put into the production process.

Before starting up, check the following;

- All moving parts can freely move
- Check oil level in the gearbox (*see appendix D for Lubrication of the gearboxes*)
- Check the integrity of all cables, mains and hand control pendant, make sure there are no cuts etc.
- Check the hand pendant controls all operate correctly.
- Check the Emergency Stop on the Pendant works, and locks all other controls so the machine cannot restart then reset on the panel.
- Check the Emergency Stop on the Panel works, and locks all other controls so the machine cannot restart then reset on the panel.
- Check the steel framework to ensure it is straight and free from damage.

## 5.3 STORAGE

There are no specific requirements for storage other than storing in a cool dry place. After a long period of storage the machines will need to be checked over thoroughly before being put into use again.



**WARNING!** After storing or transporting the machine in a cold climate and moving it into a warm location, there may be a build up of condensation within the machine and electrical controls. To prevent damage, allow the machine to adjust to the new environment temperature.



Do not store the machine outside unprotected. Equipment should be sheeted, and bare metal areas, bearings, gears and shafts suitably greased to prevent corrosion.

## 5.4 REPAIR AND MAINTENANCE

The column & boom is designed and constructed to the highest standards, using high quality components. As such this equipment should expect to have many years of operational life with only a minimal amount of regular maintenance.

To continue the longevity of the equipment, all efforts should be made to keep the column & boom clean and free from dirt or waste from the welding process.

In addition the gearbox oil levels should be checked regularly and kept at the correct levels, see Appendix D, for more information on gearbox maintenance.

At least once per year the whole installation should be inspected with particular attention paid to the following;

- Poor electrical contacts
- Switches and controls
- Loose mechanical parts, ensure all fixings are correctly tightened
- Check smooth running of boom both up/down and horizontal travel i.e. no vibrations
- Metal corrosion
- Frame damage
- Check for signs of damage to the roller bearings.
- Follow maintenance procedure for the gearboxes in Appendix D
- Check all cables for damage (mains, pendant and also any visible cable running from the panel to the motors).
- Check the emergency stops and also the correct functioning of the panel door isolator.
- Remove guards and check the condition of the spur gear and pinion on the boom and column drives.

If there is any excessive damage then the parts should be removed and replaced with new.

## 5.5 REPAIRS AND REPLACEMENT PARTS

During the warranty period repairs must only be carried out under the direction of the manufacturers. Any unauthorised repairs may damage the machine and invalidate the warranty.

It is advised that the manufacturer should be contacted for the supply of all replacement parts; this will ensure that the correct part or suitable alternative parts are supplied and used on the equipment.

## 6.0 REPLACEMENT PARTS



**WARNING!** Not following the recommendations for replacement parts in section 5.5 can have consequences for the safety of the equipment. The manufacturers cannot be held liable for any subsequent problems after fitting none recommended parts.

### 6.1 MECHANICAL PARTS LIST

Part Number	Description	Quantity
<b><u>Main Sections</u></b>		
KPMDUL0100	Column	1
KPMDUL0200	Boom	1
KPMDUL0300	Base	1
KPMDUL0400	Carriage	1
<b><u>Column</u></b>		
KPMDUL0102	Column Safety Rack	1
KPMDUL0108	Column Elevation Rack	1
KPMDUL0106	Elevation Gearbox	1
KPMDUL0107	Elevation Motor	1
KPMDUL0110	Elevation Gearbox Mounting Feet	1
KPMDUL0111	Elevation Pinion	1
KPMDUL0109	Column Limit Switches	2
KPMDUL0112	Column Strikers	2
KPMDUL0104	Carriage Bracket	1
<b><u>Boom</u></b>		
KPMDUL0207	Boom Rack	1
KPMDUL0202	Boom Gearbox	1
KPMDUL0203	Boom Gearbox Feet	1
KPMDUL0204	Boom Gearbox Adjuster Plate	1
KPMDUL0201	Boom Motor	1
KPMDUL0205	Boom Pinion	1
KPMDUL0206	Boom Shaft	1
KPMDUL0208	Boom Limit Switch	2
KPMDUL0209	Boom Striker	2
KPMDUL0222	Boom Cable Chain	1
KPMDUL0223	Cable Tray	1
<b><u>Carriage</u></b>		
KPMDUL0401	Carriage Rollers	8
KPMDUL0402	Carriage Bearings	8
KPMDUL0403	Safety Device Assembly	1
KPMDUL0404	Solenoid	1
<b><u>Base</u></b>		
KPMDUL0301	Rotation Slewing Ring	1
KPMDUL0302	Base Clamps	3

## 6.2 ELECTRICAL PARTS LIST

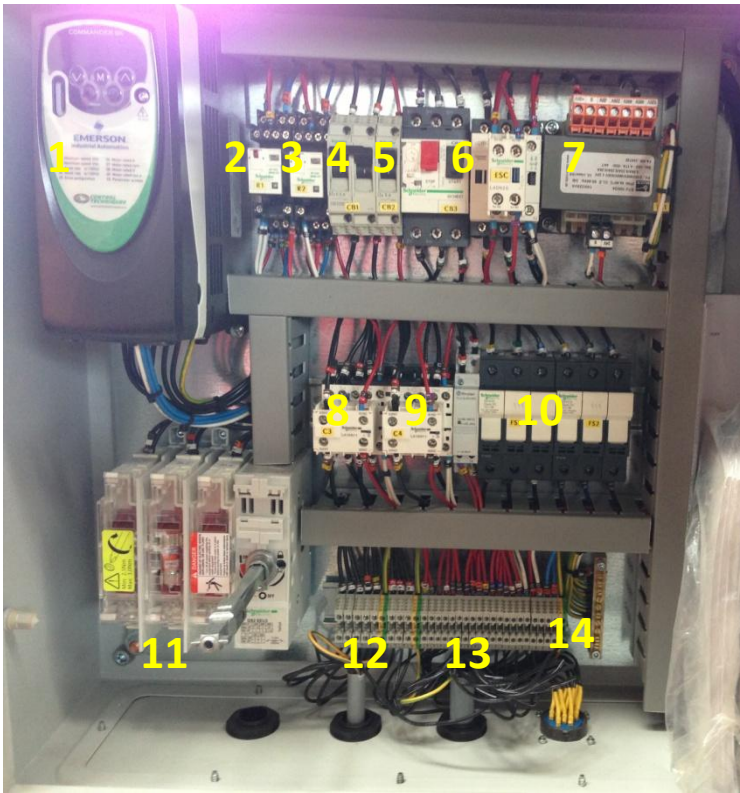

Figure 5 Panel Interior



Figure 4 Panel Exterior



Figure 3 Hand Pendant

Photo No.	Part Number	Description	Quantity
1	KP3007	Boom Inverter 3 Phase 0.37kw	1
2	KP1060	Relay	2
3	KP1020	2 Pole Circuit Breaker 0.5A	1
4	KP1012	1 Pole Circuit Breaker 5A	1
5	KP1030	Motor Circuit Breaker 1.6-2.5A	2
6	KP1041	Contactor 9A, 24VAC	1
7	KP2027	Transformer 460V:24 100VA	1
8	KP1048	3 Pole Reversing Contactor 9A, 24VAC	2
9	KP2009	Phase Detection Relay	1
10	KP1008	Fuse Holder and Fuses	2
11	KP1028	Fused Door Isolator	1
12	KP1002	Terminals (Grey)	29
13	KP1001	Earth Terminals (Green/Yellow)	3
14	KP4001	Earthing Bar 10-Way	1
15	KP1092	Power On Lamp	1
16	KP1094	Illuminated Reset Button (Blue)	1
17	KP1088	Panel Push Button (Black/White)	2
18	KP1090	Panel Emergency Stop Button	1
19	KP1065	6 Button Pendant Body	1
20	KP1068	Pendant Pushbutton (Green, Red, Yellow, Black, White)	5
21	KP2026	Speed Potentiometer	1
22	KP1075	Pendant Emergency Stop Button	1
Not Shown	KPPENCAB	Pendant Cable	15m



**APPENDIX A – OVERVIEW DRAWING**

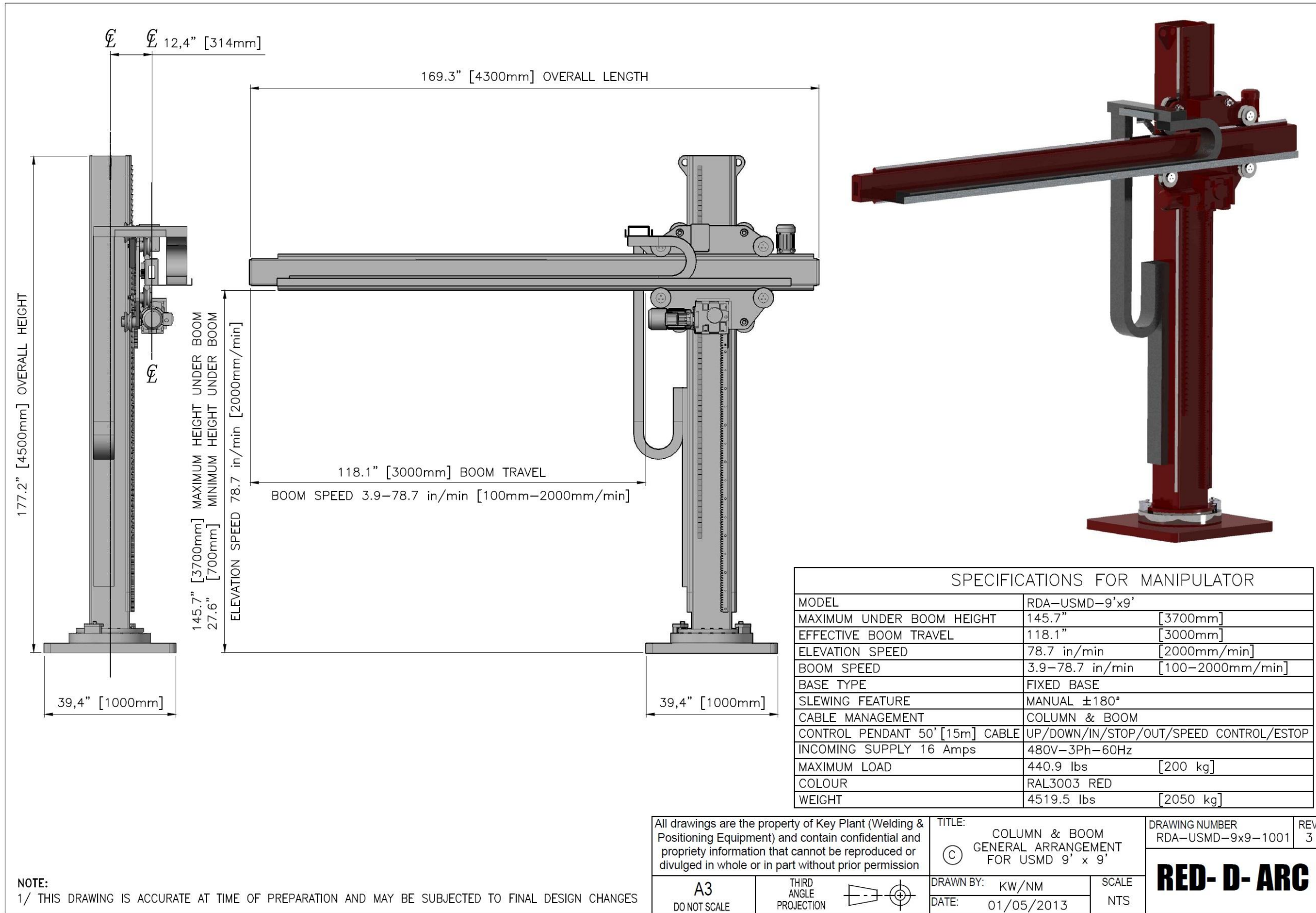

Figure 6 Overview Drawing MD 9ft x 9ft



**APPENDIX B – WIRING DIAGRAM**

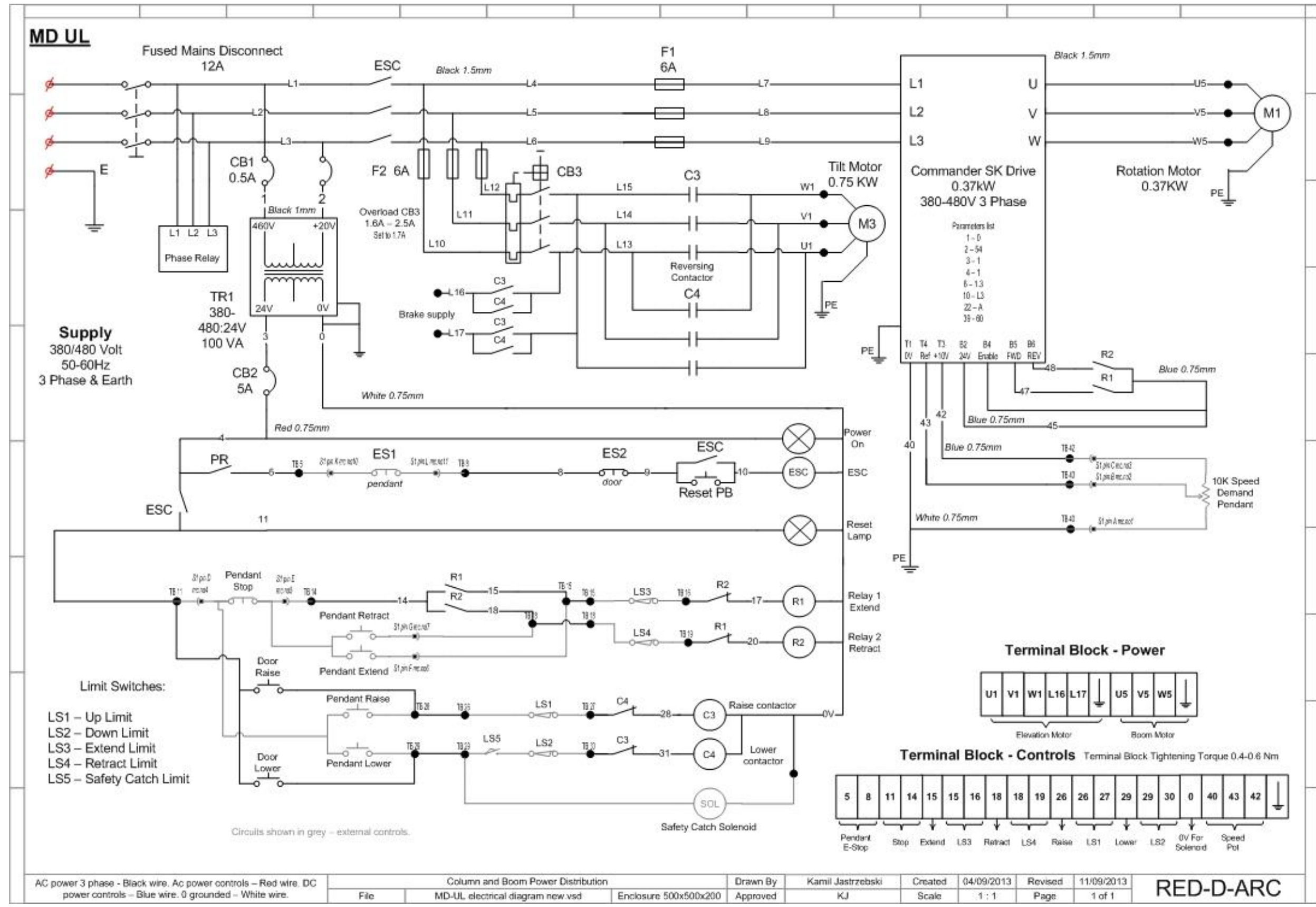

Figure 7 Wiring Diagram

**APPENDIX C – INVERTER PARAMETER SETTINGS**

The following settings have been programmed into the inverter at the factory;

<b>Parameter Number</b>	<b>Value</b>	<b>Parameter Number</b>	<b>Value</b>
<b>1</b>	0	<b>10</b>	L3
<b>2</b>	54	<b>11</b>	0
<b>3</b>	1	<b>22</b>	A
<b>4</b>	1	<b>39</b>	60
<b>6</b>	1.3		

All other values are as set by the inverter manufacturer and need not be altered.

## APPENDIX D – GEARBOX MAINTENANCE

### Startup

#### D.1 MEASURES BEFORE STARTUP

##### D.1.1 OIL LEVEL CHECK

Before connecting up the drive system to the current supply check the oil level or Shut down the gear unit by shutting off the drive unit



**WARNING!** Secure drive unit to prevent accidental startup. Affix notice at the switch-on point.



**Note:** In case of tandem gear units, each single gear unit should be inspected separately. Check oil level with the oil cooled down. Even after a short run, oil needs a longer 'rest' in order to release possible air bubbles.

##### D.1.1.1 CHECKING THE OIL LEVEL IN THE GEAR UNIT HOUSING

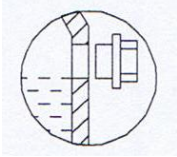

Screw out the plug screw at the point marked with this symbol.



**Note:** If the oil level is correct, a small amount of oil may flow out; the oil must at least come up to the lower edge of the bore.

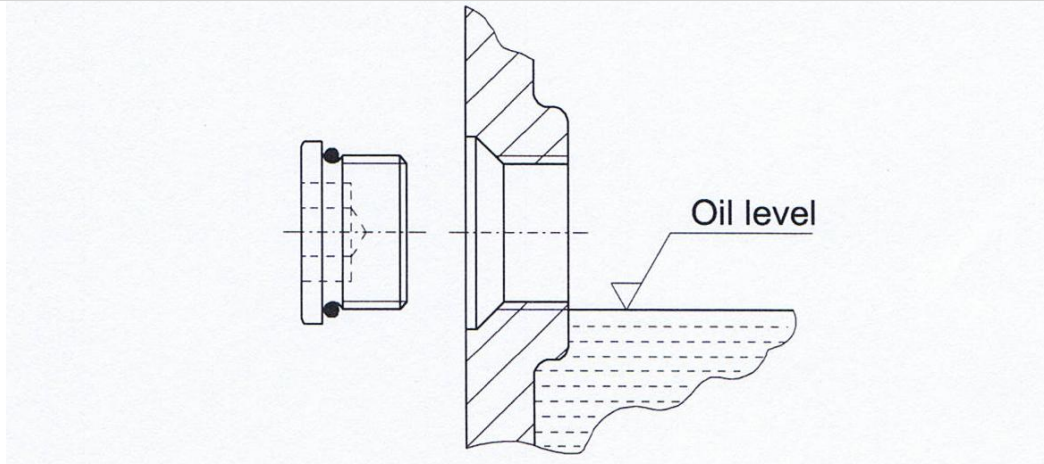

Any oil escaping should be removed immediately with oil binding agent in an environmentally compatible way.

For drives with only one plug screw, checking the oil level is not possible.

### D.1.1.2 OIL SIGHT GLASS (SPECIAL FEATURE)

If an oil inspection glass is provided, the oil level must be visible in the middle of the inspection glass.

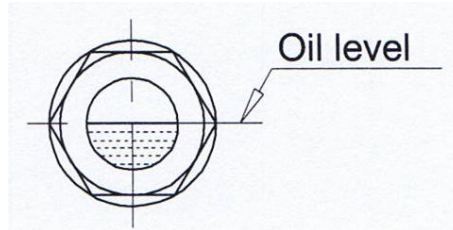

### D.1.1.3 DIPSTICK (SPECIAL FEATURE)

Check oil level with dipstick:

The oil level must be between the lower and upper mark of the dipstick.

### D.1.2 STARTUP WITHOUT LONG TERM PRESERVATION

**MOTOX**<sup>®</sup> drives are delivered with the appropriate lubricants ready for operation depending on the specified conditions of use.



On gear systems with the required housing ventilation the required ventilator filter is delivered loose with the unit. It must be replaced with the appropriate screw plug before the initial start-up of the gear unit.



It must be used at the position indicated by this symbol.

### D.1.3 STARTUP IN CASE OF LONG TERM PRESERVATION

#### D.1.3.1 LONG TERM PRESERVATION UP TO 18 MONTHS



Before starting up the gear unit, it should be filled with lubricant (see D.1.4).

#### D.1.3.2 LONG TERM PRESERVATION UP TO 36 MONTHS



The gear unit is completely filled with oil. Before the start up, the oil level should be corrected according to the type of construction.

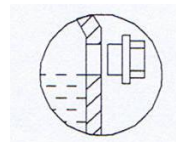

The oil level should be reduced to the level marked with this symbol (see D.1.1).



Any oil escaping should be removed immediately with oil binding agent in an environmentally compatible way.

## D.1.4 FILLING WITH LUBRICANT

- Screw out venting screw or venting filter or plug screw at the highest point (see 3.2 or point of ventilation).



**Fill gear unit up with fresh oil using a filling filter (max. filter coarseness 60 µm). The quantity of oil depends on the mounting position!**



**Note:** Recommendations on the oil to be used should be taken from section 10. "Maintenance and repair"

Data, such as oil grade, oil viscosity and oil quantity required will be found on the rating plate

**Finally, check the oil level (see 7.1.1).**



**Any oil escaping should be removed immediately with oil binding agent in an environmentally compatible way.**

## D.1.5 DRIVE WITH BACKSTOP



**Secure drive unit to prevent accidental startup. Affix notice at the switch-on point.**



**Check the direction of rotation before putting into service!**

E.g. by manually turning the input shaft or the motor. Check the motor direction of rotation according to the phase sequence, swap two supply leads if necessary.

## D.2 MAINTENANCE AND REPAIR

### D.2.1 GENERAL INFORMATION ON MAINTENANCE



All maintenance and repair work should be carried out with due care and only by thoroughly trained personnel.

The periods listed in the table below, are largely dependent on the conditions of use of use of the gear unit. For this reason, it is only possible to give average periods which refer to a

- **Daily operating time of**      **24 h**
- **Duty factor of**                      **ED 100%**
- **Input drive speed of**              **1500 min<sup>-1</sup>**
- **Max. Oil temperature of**        **100°C**

**NOTE:** Under different operating conditions, the periods should be adjusted accordingly.

Measures	Causes	Remedy
Observe/check gear unit noise for changes	from time to time, more often during operation if possible	-
Observe/check oil temperature	from time to time, more often during operation if possible	-
Oil level check	monthly	see D.1.1
Check gear unit for leakage	monthly	-
Initial oil change after startup	after approx. 10000 operating hours, at the latest after 3 years	see D.2.2.1
Subsequent oil changes	every 3 years or 10000 operating hours	see D.2.2.1
Clean vent plug	every 3 months	see D.2.2.2
Clean drive	according to the degree of contamination	see D.2.2.3
Check all fixing screws for tightness	at least once a year	see D.2.2.4
Carry out complete inspection of gear unit	at least once a year	see D.2.2.5

## D.2.2 DESCRIPTION OF MAINTENANCE AND REPAIRS

### D.2.2.1 PERFORM OIL CHANGE OR OIL FLUSHING



**NOTE:** Different types of oil must not be mixed.

Types of oil: - mineral oil (CLP oil DIN 51517/3)  
- synthetic oil with a specific base (PGLP-Öl)

Specifications like oil type, oil viscosity and required oil quantity are shown on the name plate.



**Oil change and oil flushing:**  
If using the same type of oil as before, use only that oil.  
If using a new oil type, use only the new type.

Thoroughly remove oil sludge, abraded material and used oil residue from the housings by oil flushing.



High-viscosity oils must be warmed beforehand. The oil should be drained off after shutdown, while the gear unit is still warm.

Shut down the gear unit by shutting off the drive unit.



Secure drive unit to prevent accidental startup. Affix notice at the switch-on point.

1. Place a suitable collection receptacle under the oil drain plug of the gear unit housing.
2. Unscrew vent plug on the upper side of the housing.
3. Unscrew oil drain plug and drain oil off into the receptacle.



There is a risk of scalding from the hot oil emerging. Wear protective gloves.

4. Screw in oil drain plug.



**Note:** Check condition of seal ring, use new seal ring if necessary.

5. Filling with lubricant sees D.1.4
6. Screw vent plug on the upper side of the housing.



## D.2.2.2 CLEAN VENT PLUG

The vent plug must be cleaned after deposit of a dust layer – at least every 3 months. For this the filter must be unscrewed, flushed out with cleaning benzene or a similar cleaning agent and dried or blown through with compressed air.



- Ensure adequate ventilation.
- Do not inhale vapours.
- Do not smoke.
- Explosion hazard.

## D.2.2.3 CLEAN THE DRIVE

Shut down the gear unit by shutting off the drive unit.



Secure drive unit to prevent accidental startup. Affix notice at the switch-on point.

Keep drives free of dirt and dust, etc in order to ensure sufficient heat dissipation. Cleaning the drive with a high-pressure cleaning device is not permissible. Do not use sharp-edged tools.

## D.2.2.4 CHECKING ALL FIXING SCREWS FOR TIGHTNESS

Shut down the gear unit by shutting off the drive unit.



Secure drive unit to prevent accidental startup. Affix notice at the switch-on point.

Check all fixing screws for tightness with a torque wrench

Thread size	Tightening torque	Property class min.
M 6	10 Nm	8.8
M 8	25 Nm	
M 10	50 Nm	
M 12	90 Nm	
M 16	210 Nm	
M 20	450 Nm	
M 24	750 Nm	
M 30	1500 Nm	
M 36	2500 Nm	

**Note:** Unserviceable screws should be replaced by new ones of the same property class and type.

## D.2.2.5 INSPECTION OF THE DRIVE

The drive should be checked annually

In addition, the drive should be checked according to the criteria described in section 2. "Safety notes," e.g. check tight fit of the protective devices.

Any damage of the coating should be repaired by an expert.

## D.2.3 LUBRICANTS

Oil selection should always be determined by the oil viscosity (ISO VG class) specified on the rating plate of the gear unit. The viscosity class is valid for the operating conditions agreed on by contract.

Under different operating conditions, it will be necessary to consult us.

We have put together a list of suitable lubricants for the gear unit in the table below.

We are acquainted with the composition of these lubricants and know that in accordance with the latest technology, they possess values in respect of loadability, corrosion protection, load carrying capacity with micro-pitting, as well as compatibility with seals and internal coating on which the design of the gear unit has been based.

Thus we recommend that our customer should select a lubricant from this table, taking in account the viscosity class stated on the rating plate.

**The lubricants listed have no approval according to USDA –H1/-H2 (United States Department of Agriculture) and are as such not, or only limited approved, for use in the food or pharmaceutical industry. The lubricants are not, or only limited biologically decomposable. They are usually according to the Classes 2 or 1 of hazard for water.**











**If lubricants are necessary according to these classifications, please contact the factory.**

**If the gearboxes are filled with special lubricants from the factory for the cases given above, this can be seen on the name plate e.g. CLP-H1 VG220 or CLP E VG220.**

**Note:** As a precaution against misunderstandings, we would like to point out that the recommendation does not imply any release in the sense of a warranty for the quality of the lubricant provided by your supplier. Each lubricant manufacturer must warrant the quality of his product himself.

If you do not follow our recommendations, you must take the responsibility for the technical suitability of the lubricant.

In the case of synthetic oils not listed in the table below, the corrosiveness of the oil to our internal coating should be checked. A check of this nature is carried out by us at cost (cost on request)

Lubricant	Designation according to DIN 51502	Examples of lubricants										
												
Synthetic Oils 2)	OIL PGLP ISOVG460	Degol GS460	Enersyn SG-XP 460	Polydea PGLP460	GLYCO-LUBE 460	Renodiol PGP460	Syntheso D460EP	Glygoyle HE460	Optiflex A460	TIVELA OIL SD		TRIBOL 800/460
	OIL PGLP ISOVG220	Degol GS220	Enersyn SG-XP 220	Polydea PGLP220	GLYCO-LUBE 220	Renodiol PGP220	Syntheso D220EP	Glygoyle 30	Optiflex A220	TIVELA OIL WB		TRIBOL 800/220
Lithium saponified anti-friction bearing greases NLGI 3/2		Aralub HL3, HL2	Energrease LS3, LS2	Glissando 30, 20	BE-ACON 3	Renolit FWA220, FWA160	CENTRO-PLEX GLP402	Mobilux 3, 2	Longtime PD2	ALVANIA R3, R2	Wiolub LFK2	TRIBOL 4020/220-2

We would be pleased to recommend further suitable lubricants of the makes ADDINOL, CASTROL, FUNCHS Lubritech, OMV, STATOIL, TEXACO, TUNAP and VALVOLINE.

Synthetic lubricants (polyglycols) in accordance with designation PGLP as per DN51 502. These oils are distinguished by their high aging resistance and favourable effect on the efficiency of the gear unit.

They are suitable for the following operating temperatures:

PGLP ISO VG 220: -30°C ... +100°C

PGLP ISO VG 460: -15°C ... +100°C

The maximum temperatures can be exceeded by 10K for a short time.



**Note:** If operating temperature of the drive exceeds or undershoots the limit values, the oil selected should be checked for suitability.

## APPENDIX E – CERTIFICATIONS

### E.1 CE CERTIFICATE

**Machine Type** Mid Duty Column & Boom

**Model** MD

We hereby certify that the above machine has been manufactured by Key Plant Automation Limited, and conforms to the essential requirements of the following E. U. Directives;

Supply of machinery (Safety) Regulations implementing the EC Machinery Directive 89/392/EEC amended 91/368/EEC and 93/44/EEC and 93/68/EEC codified to 98/37/EC.

73/23 EEC Low Voltage Directive amended by the directive 93/68 EEC regarding safety of electrical equipment.

89/336 EEC Electro-Magnetic Compatibility amended by directives 92/31 EEC and 93/68 EEC.

As implemented by the UK. Supply of Machinery (Safety) Regulations 1992.

Authorised signatory

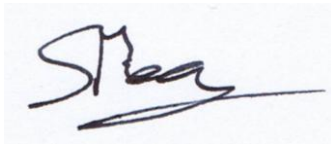

Steve Piercy  
Engineering Manager

## E.2 UL LISTING



### ONLINE CERTIFICATIONS DIRECTORY

#### **GPNY.E353668 Factory Automation Equipment**

[Page Bottom](#)

#### **Factory Automation Equipment**

[See General Information for Factory Automation Equipment](#)

**KEY PLANT AUTOMATION LTD**

E353668

KENSINGTON HOUSE

7 ROE LANE

SOUTHPORT

MERSEYSIDE, PR9 9DT UNITED KINGDOM

**Column and booms**, Model MD AMxBM. Where A = 2, 3, or 4 and B = 2, 3, or 4.

Model HD AMxBM. Where A = 3, 4, 5, 6, 7 or 8 and B = 3, 4, 5, 6 or 7.

**Positioners**, Model VP X. Where X = 0.25, 0.75, 1.5, 3, 5, 10, 15, 20, 25 or 35.

**Rotators**, Model CR X. Where X = 10, 20, 30, 60, 100, 125, 200, 300, 400 or 500.

[Last Updated](#) on 2012-06-25

[Questions?](#)

[Print this page](#)

[Terms of Use](#)

[Page Top](#)

© 2012 UL LLC

When the UL Leaf Mark is on the product, or when the word "Environment" is included in the UL Mark, please search the [UL Environment database](#) for additional information regarding this product's certification.

The appearance of a company's name or product in this database does not in itself assure that products so identified have been manufactured under UL's Follow-Up Service. Only those products bearing the UL Mark should be considered to be Listed and covered under UL's Follow-Up Service. Always look for the Mark on the product.

UL permits the reproduction of the material contained in the Online Certification Directory subject to the following conditions: 1. The Guide Information, Designs and/or Listings (files) must be presented in their entirety and in a non-misleading manner, without any manipulation of the data (or drawings). 2. The statement "Reprinted from the Online Certifications Directory with permission from UL" must appear adjacent to the extracted material. In addition, the reprinted material must include a copyright notice in the following format: "© 2012 UL LLC".



## E.3 CAS LISTING



### ONLINE CERTIFICATIONS DIRECTORY

## GPNY7.E353668 Factory Automation Equipment Certified for Canada

[Page Bottom](#)

## Factory Automation Equipment Certified for Canada

[See General Information for Factory Automation Equipment Certified for Canada](#)

### KEY PLANT AUTOMATION LTD

E353668

KENSINGTON HOUSE

7 ROE LANE

SOUTHPORT

MERSEYSIDE, PR9 9DT UNITED KINGDOM

**Column and booms**, Model MD AMxBM. Where A = 2, 3, or 4 and B = 2, 3, or 4.

Model HD AMxBM. Where A = 3, 4, 5, 6, 7 or 8 and B = 3, 4, 5, 6 or 7.

**Positioners**, Model VP X. Where X = 0.25, 0.75, 1.5, 3, 5, 10, 15, 20, 25 or 35.

**Rotators**, Model CR X. Where X = 10, 20, 30, 60, 100, 125, 200, 300, 400 or 500.

[Last Updated](#) on 2012-06-25

[Questions?](#)

[Print this page](#)

[Terms of Use](#)

[Page Top](#)

© 2012 UL LLC

When the UL Leaf Mark is on the product, or when the word "Environment" is included in the UL Mark, please search the [UL Environment database](#) for additional information regarding this product's certification.

The appearance of a company's name or product in this database does not in itself assure that products so identified have been manufactured under UL's Follow-Up Service. Only those products bearing the UL Mark should be considered to be Listed and covered under UL's Follow-Up Service. Always look for the Mark on the product.

UL permits the reproduction of the material contained in the Online Certification Directory subject to the following conditions: 1. The Guide Information, Designs and/or Listings (files) must be presented in their entirety and in a non-misleading manner, without any manipulation of the data (or drawings). 2. The statement "Reprinted from the Online Certifications Directory with permission from UL" must appear adjacent to the extracted material. In addition, the reprinted material must include a copyright notice in the following format: "© 2012 UL LLC".

## INDEX

<b>B</b>		<b>O</b>	
Base .....	6	oil levels.....	18
Boom .....	6	Operating .....	15
Breakdown.....	16	Operating Instructions .....	10
<b>C</b>		Operator.....	4
CAS Listing .....	35	<b>OPERATORS</b> .....	7
CE Certificate of Conformity .....	33	Overview .....	22
Cleaning .....	16	<b>P</b>	
Column .....	6	Panel .....	6, 10, 17, 21
Common Mistakes.....	16	<b>PARTS LIST</b>	
Contents .....	2	Electrical.....	21
<b>D</b>		Mechanical.....	20
Disclaimer .....	5	Pendant .....	6, 11, 17, 21
Drive Unit.....	6	Preface .....	4
<b>E</b>		<b>R</b>	
EEC Electro-Magnetic Compatibility .....	33	Replacement Parts .....	20
Emergency Stops .....	8	Replacment Parts .....	19
Emissions .....	9	<b>S</b>	
<b>F</b>		Safety .....	7
<b>FIXED BASE</b> .....	12	Safety Notices .....	5
<b>G</b>		Safety Officer.....	4
gearbox .....	17, 18	Safety Rules.....	7
Gearbox Maintenance .....	25	Service Engineer .....	4
<b>I</b>		<b>SERVICE ENGINEERS</b> .....	7
Installation .....	17	Set UP .....	12
Introduction.....	6	Signs .....	9
Inverter Parameter .....	24	Slewing Ring .....	6
<b>L</b>		Specification .....	22
Low Voltage Directive.....	33	starting up .....	17
lubricants.....	26, 31, 32	Stopping the Rotators .....	16
<b>M</b>		Storage .....	18
Machine Details .....	10	Supply of machinery (Safety) Regulations.....	33
Maintenance.....	7, 17, 18	Switching On .....	14
manipulator .....	6	<b>T</b>	
<b>N</b>		<b>TRAVERSING BOGIE</b> .....	12
Nomenclature.....	6	<b>U</b>	
<b>O</b>		UL Listing .....	34
<b>P</b>		User .....	4
<b>R</b>		Users .....	7
<b>S</b>		<b>W</b>	
<b>T</b>		Welding .....	15
<b>U</b>		Wiring Diagram .....	23
<b>V</b>		Workspace .....	8
<b>W</b>			